



BONTRAGER

WHEEL SPECIFICATIONS

Aeolus RSL 37 TLR Clincher Disc Rear Wheel



Wheel Components

TCG Part Number	Description
598982/599064	Wheel
NA	Hub (OE use only, not available for aftermarket purchase)
NA	Rim
W596858	Drive Side Spokes
W596859	Non-Drive Side Spokes
W593860	Nipples
W548391	Tubeless Rim Strip
W597345	Tubeless Valve Stem

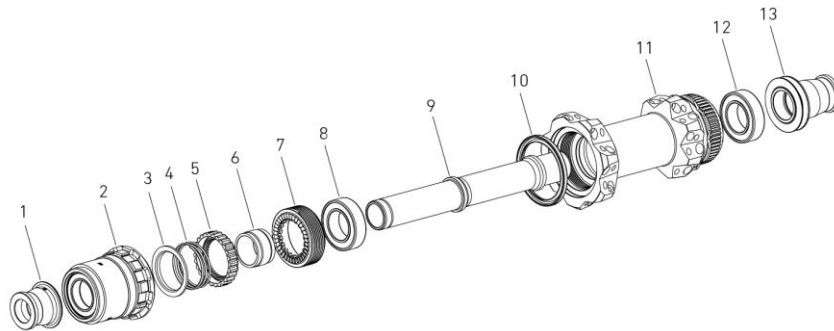

Hub Service Parts

Diagram Number	TCG Part Number	Description
Not Shown	1051527	End Cap Driveside - Shimano 11-Speed Road
1	1051528	End Cap Driveside - SRAM XDR
Not Shown	5290201	End Cap Kit - Shimano QR (includes drive and non-drive side end caps)
Not Shown	5290202	End Cap Kit - SRAM XDR QR (includes drive and non-drive side end caps)
Not Shown	1048776	Freehub Shimano 11-Speed Road (Includes 12mm drive side end cap)
2	1048777	Freehub SRAM XDR (Includes 12mm drive side end cap)
Not Shown	5291427	Freehub Campagnolo N3W (Includes 12mm drive side end cap)
3	1048769	Spring Seat
4	1048770	Ratchet EXP Spring
5	1048775	Ratchet EXP Star Ratchet - 36T
6	1048774	Freehub Spacer
7	1048773	Ratchet EXP Threaded Star Ratchet - 36T
8	1050471	Ball Bearing 15267 15x26x7mm (Steel, stock)
9	1048771	Axle
10	W211591	Seal Hub Shell/Rotor
11	NA	Hub Shell
12	1050471	Ball Bearing 15267 15x26x7mm (Steel, stock)
13	1048772	Axle End Cap Non-Drive Side

Wheel Building Information and Specifications

Value	Description or Specification
Wheel Building Information	
0.4mm	Hop (mm)
0.3mm	Wobble (mm)
0.6mm	Dish (mm)
NA	Wheel stress level drive side up (degrees of rotation, measured on Bontrager Stressor)
NA	Wheel stress level non-drive side up (degrees of rotation, measured on Bontrager Stressor)
253 lbs min, 340 lbs max OR 115 kgf min, 154 kgf max	Spoke Tension, Drive Side
115lbs min OR 52 kgf min	Spoke Tension, Non-Drive Side
Lacing Pattern drive side	2 cross. Spokes woven, with the pulling spoke on the outside of first cross and inside of the second cross. Second hole CW from the valve hole is a pulling spoke.
Lacing pattern non-drive side	2 cross. Spokes woven, with the pulling spoke on the inside of first cross and outside of the second cross. Second hole CW from the valve hole is a pushing spoke.
Additional build instructions	NA
Size Specifications	
276mm	Spoke Length Drive
278mm	Spoke Length Non-Drive
571mm	Rim ERD
37mm	Rim height
27.5mm	Rim outer width
21mm	Rim inner hook bead width
NA	Rim spoke offset
Other Specifications	
725g	Wheel weight
390g	Rim weight
210g	Hub weight
Carbon with laser etched graphics	Wheel Color
Black	Hub color
Black	Spoke color
Carbon with laser etched graphics	Rim color
24	Spoke Count
14/17G	Spoke Gauge
Centerlock	Disc brake interface
Yes	Tubeless ready